

DATA SHEET

# SKY65080-70LF: 1500 to 2500 MHz Low-Noise Power Amplifier Driver

## Applications

- UHF television
- TETRA radios
- PCS, DCS, 2.5G, 3G handsets
- ISM band transmitters
- WCS fixed wireless
- 802.16 WiMAX
- 3GPP LTE

## Features

- Wideband frequency range: 1500 to 2500 MHz
- Low noise figure: 2.3 dB
- High linearity: IIP3 = +25.5 dBm
- Output P1dB = +21 dBm
- High gain: 15 dB
- Single DC supply: +5 V
- On-chip bias circuit
- SOT-89 (4-pin, 2.4 x 4.5 mm) package (MSL1, 260 °C per JEDEC J-STD-020)



Skyworks Green™ products are compliant with all applicable legislation and are halogen-free. For additional information, refer to *Skyworks Definition of Green™*, document number SQ04-0074.

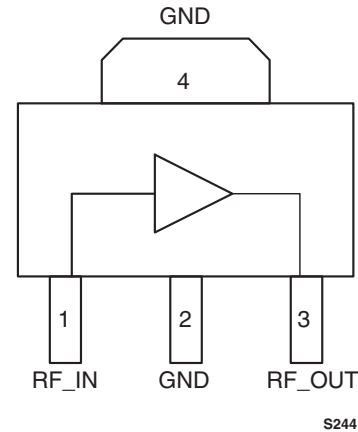
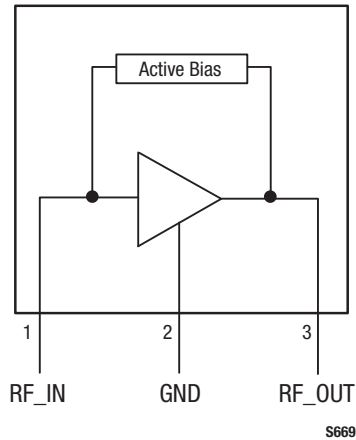

**Figure 1. SKY65080-70LF Pinout - 4-Pin SOT Package (Top View)**

## Description

Skyworks SKY65080-70LF is a high performance, ultra-wideband power amplifier (PA) driver with superior output power, low noise, linearity, and efficiency. The device provides a 2.3 dB noise figure (NF) and an output power at 1 dB compression of +21 dBm, making the SKY65080-70LF ideal for use in the driver stage of infrastructure transmit chains.

The SKY65080-70LF uses low-cost surface-mount technology (SMT) in the form of a 4-pin, 2.4 x 4.5 mm small outline transistor (SOT) package. The device package and pinout are shown in Figure 1 and a functional block diagram is provided in Figure 2.



**Figure 2. SKY65080-70LF Functional Block Diagram**

**Table 1. SKY65080-70LF Signal Descriptions**

Pin	Name	Description
1	RF_IN	RF input
2	GND	Ground
3	RF_OUT	RF output
4	GND	Ground

### Technical Description

The SKY65080-70LF is a single stage, low-noise PA that operates with a single 5 V power supply connected through an RF choke (inductor L1) to the output signal (pin 3). The bias current is set by the on-chip active bias composed of current mirror and reference voltage transistors, which allow excellent gain tracking over temperature and voltage variations. The device is externally RF matched using surface mount components to facilitate operation over a frequency range of 1500 to 2500 MHz.

### Electrical and Mechanical Specifications

Signal pin assignments and functional pin descriptions are described in Table 1. The absolute maximum ratings of the SKY65080-70LF are provided in Table 2. The recommended operating conditions are specified in Table 3 and electrical specifications are provided in Table 4.

Typical performance characteristics of the SKY65080-70LF are illustrated in Figures 3 through 10.

**Table 2. SKY65080-70LF Absolute Maximum Ratings<sup>1</sup>**

Parameter	Symbol	Minimum	Maximum	Units
Supply voltage	V <sub>CC</sub>		6	V
RF output power	P <sub>OUT</sub>		+24	dBm
Supply current	I <sub>CC</sub>		100	mA
Power dissipation	P <sub>D</sub>		0.6	W
Operating case temperature	T <sub>C</sub>	-40	+85	°C
Storage temperature	T <sub>ST</sub>	-55	+125	°C
Junction temperature	T <sub>J</sub>		+150	°C

<sup>1</sup> Exposure to maximum rating conditions for extended periods may reduce device reliability. There is no damage to device with only one parameter set at the limit and all other parameters set at or below their nominal values. Exceeding any of the limits listed here may result in permanent damage to the device.

**ESD HANDLING:** Although this device is designed to be as robust as possible, electrostatic discharge (ESD) can damage this device. This device must be protected at all times from ESD when handling or transporting. Static charges may easily produce potentials of several kilovolts on the human body or equipment, which can discharge without detection. Industry-standard ESD handling precautions should be used at all times.

**Table 3. SKY65080-70LF Recommended Operating Conditions**

Parameter	Symbol	Min	Typ	Max	Units
Supply voltage	V <sub>CC</sub>	4.75	5.0	5.5	V
Operating frequency	f	1500	1750	2500	MHz
Operating case temperature	T <sub>J</sub>	-40	+25	+85	°C

**Table 4. SKY65080-70LF Electrical Characteristics<sup>1,2</sup>**

(V<sub>CC</sub> = +5 V, T<sub>C</sub> = 25 °C, f = 1850 MHz, Unless Otherwise Noted)

Parameter	Symbol	Test Conditions	Min	Typ	Max	Units
Frequency	f		1700	1850	2000	MHz
Small signal gain	G	P <sub>IN</sub> = -15 dBm	14	15		dB
Input return loss	S <sub>11</sub>	P <sub>IN</sub> = -15 dBm	10	11		dB
Output return loss	S <sub>22</sub>	P <sub>IN</sub> = -15 dBm	10	11		dB
Output power @ 1 dB compression	OP1dB	CW		+21		dBm
Operating current @ OP1dB	I <sub>CC,OP1DB</sub>			75	100	mA
Third order input intercept point	IIP3	P <sub>IN/tone</sub> = -10 dBm, Δf = 1 MHz	+24.0	+25.5		dBm
Third order output intercept point	OIP3	P <sub>IN/tone</sub> = -10 dBm, Δf = 1 MHz	+39.0	+40.5		dBm
Noise figure	NF	Small signal		2.3	3.0	dB
Quiescent current	I <sub>CCQ</sub>	No RF	40	66	90	mA

<sup>1</sup> Performance is guaranteed only under the conditions listed in this table.

<sup>2</sup> Matching circuit component values (see Table 5) are optimized to yield maximum IIP3 within the range of 1700 MHz to 2000 MHz.

## Typical Performance Characteristics

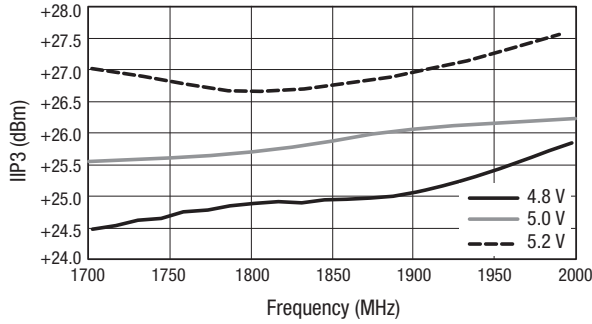

**Figure 3. Typical IIP3 vs Frequency Over VCC (Input = -10 dBm CW)**

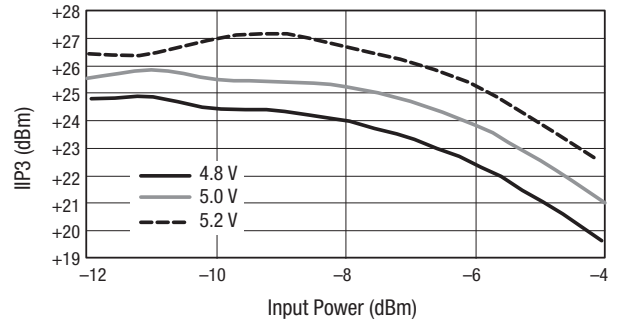

**Figure 4. Typical IIP3 vs Input Power Over VCC @ 1700 MHz**

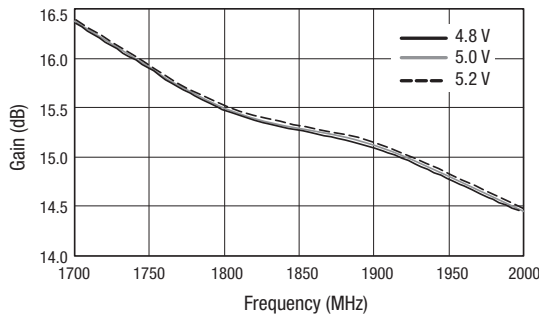

**Figure 5. Gain vs Frequency Over VCC**

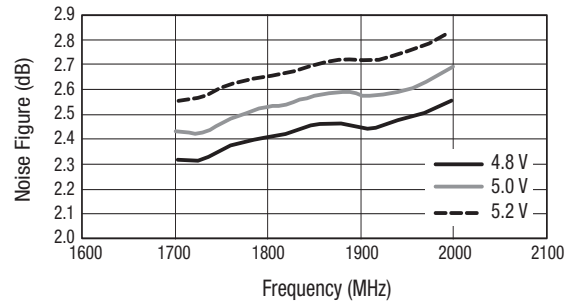

**Figure 6. Noise Figure vs Frequency Over VCC**

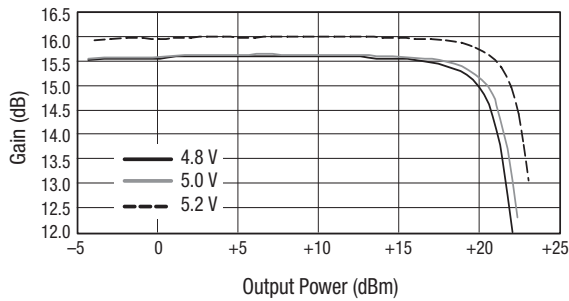

**Figure 7. Typical Gain vs Output Power Over VCC (CW @ 1800 MHz)**

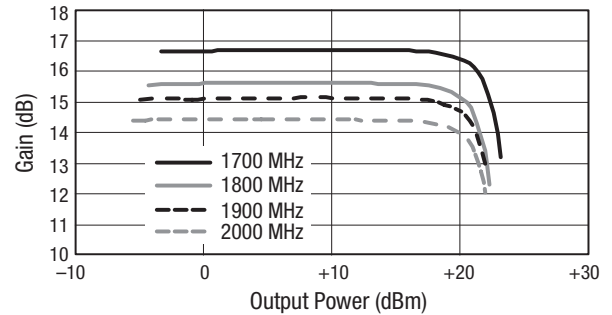

**Figure 8. Gain vs Output Power Over Frequency**

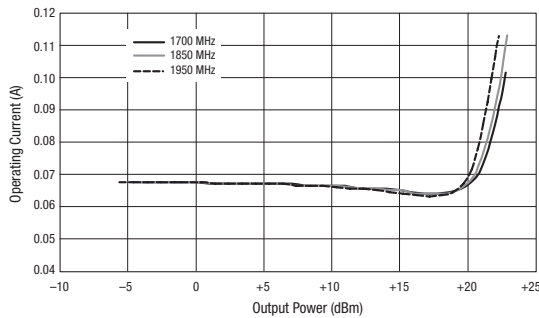

**Figure 9. Operating Current vs Output Power Over Frequency**

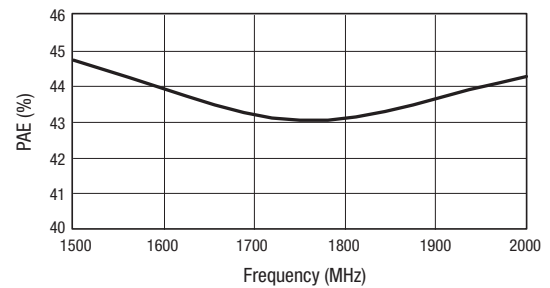

**Figure 10. Power-Added Efficiency vs Frequency**

### Evaluation Board Description

The SKY65080-70LF Evaluation Board is used to test the performance of the SKY65080-70LF PA driver. An assembly drawing for the Evaluation Board is shown in Figure 11, and the layer detail is provided in Figure 12. A schematic for a suggested matching circuit is shown in Figure 13, and the component values are shown in Table 6.

Capacitors C7, C8, and C9 provide DC bias decoupling for VCC. Pins 1 and 3 are the RF input and output signals, respectively. External DC blocking is required on the input and output, but can be implemented as part of the RF matching circuit. Pin 2 and the package backside metal, pin 4, are ground pins that provide the DC and RF ground, respectively.

### Testing Procedure

Use the following procedure to set up the SKY65080-70LF Evaluation Board for testing:

1. Connect a 5.0 V supply to VCC. If available, enable the current limiting function of the power supply to 100 mA.
2. Connect a signal generator to the RF signal input port. Set it to the desired RF frequency at a power level of -15 dBm or less to the Evaluation Board but do NOT enable the RF signal.
3. Connect a spectrum analyzer to the RF signal output port.
4. Enable the power supply.
5. Enable the RF signal.
6. Take measurements.

**CAUTION:** If any of the output signals exceed the rated maximum values, the SKY65080-70LF Evaluation Board can be permanently damaged.

### Circuit Design Considerations

The following design considerations are general in nature and must be followed regardless of final use or configuration.

- Paths to ground should be made as short as possible.
- The ground pad of the SKY65080-70LF power amplifier has special electrical and thermal grounding requirements. This pad is the main thermal conduit for heat dissipation.

Since the circuit board acts as the heat sink, it must shunt as much heat as possible from the amplifier. As such, design the connection to the ground pad to dissipate the maximum wattage produced to the circuit board. Multiple vias to the grounding layer are required.

**NOTE:** Junction temperature ( $T_j$ ) of the device increases with a poor connection to the slug and ground. This reduces the lifetime of the device.

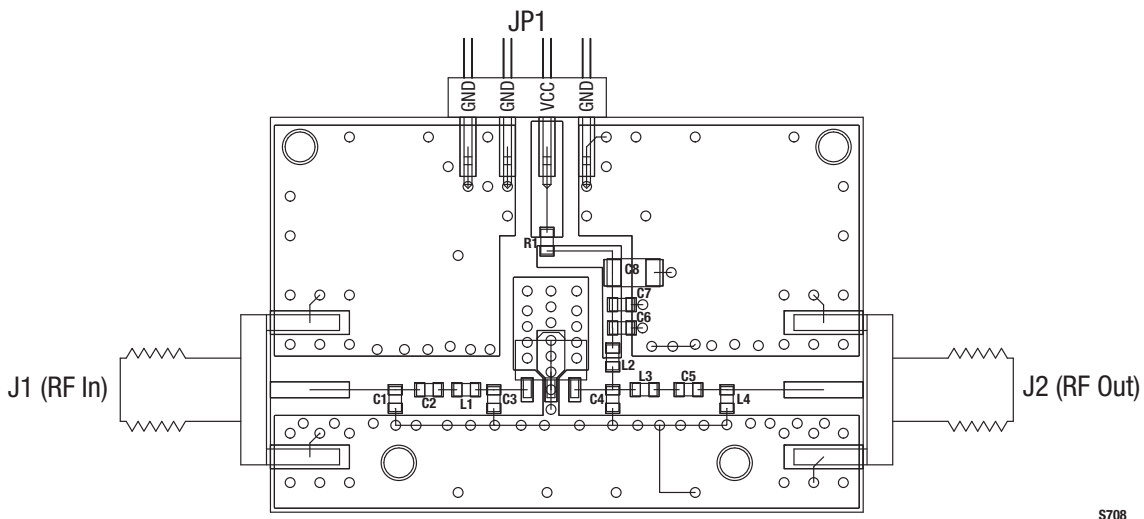

S708

Figure 11. Evaluation Board Assembly Drawing

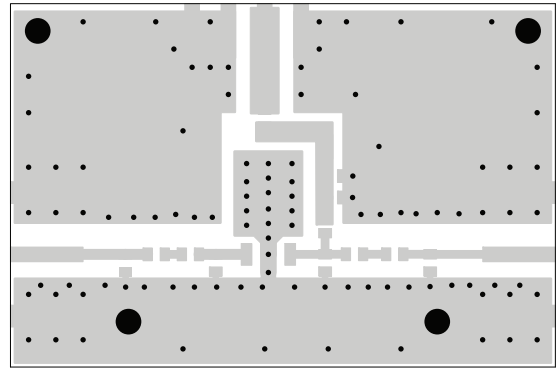

Layer 1: Top - Metal

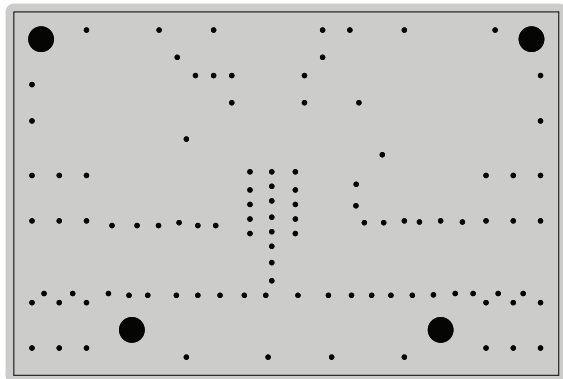

Layer 2: Ground

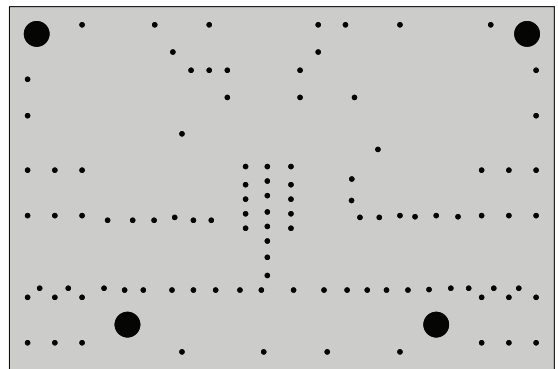

Layer 3: Ground

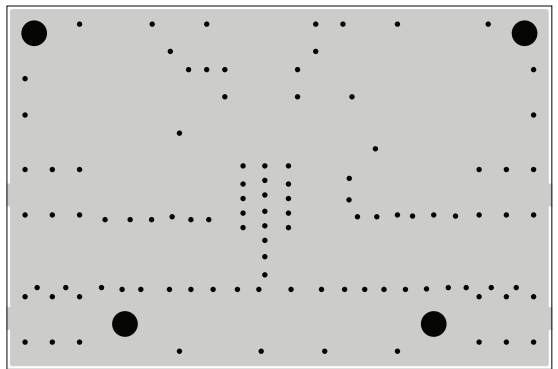

Layer 4: Solid Ground Plane

S1699

**Figure 12. Evaluation Board Layer Detail**

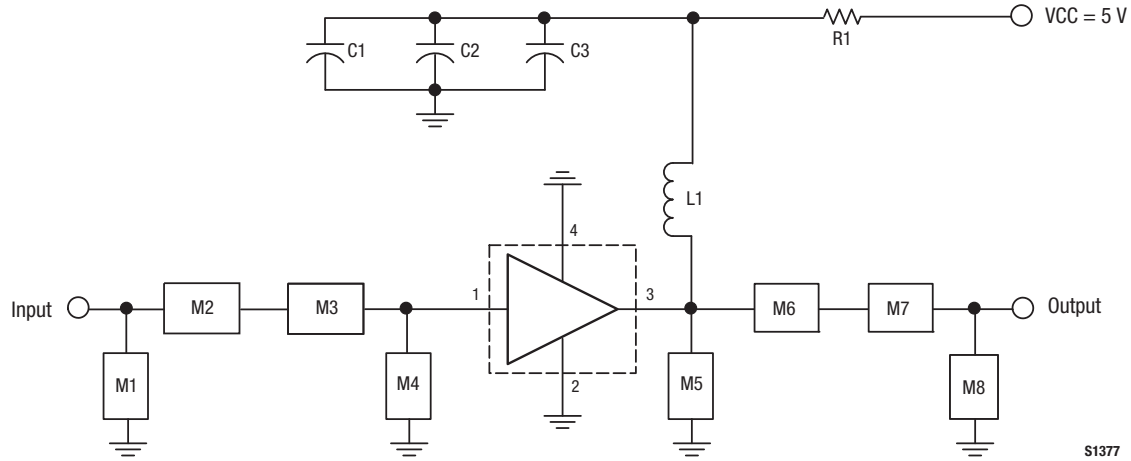

S1377

**Figure 13. SKY65080-70LF Evaluation Board Schematic (1700 MHz to 2000 MHz, IIP3 Matched)**

**Table 5. SKY65080-70LF (SOT-89 Package) Evaluation Board Bill of Materials**

Component	Size	Value	Vendor	MFr Part Number
C1	0805	10 $\mu$ F	Panasonic	ECJ3YB0J106K
C2	0603	2.7 pF	Johanson	500R14N2R7DV6S-AA
C3	0603	DNI	-	-
L1	0603	4.7 nH	Taiyo-Yuden	HK1608RN7S-T
M1	0603	DNI	-	-
M2	0603	3.6 pF	Johanson	251R14S3R6BV4SX
M3	0603	2.2 nH	Johanson	L-14C2N2SV4SX
M4	0603	1.8 pF	Murata	GRM39C0G1R8D050BK
M5	0603	DNI	-	-
M6	0603	1.5 nH	Johanson	L-14C1N5SV4SX
M7	0603	33 pF	Johanson	500R14N330JV4T
M8	0603	DNI	-	-
R1	0603	0 $\Omega$	Kamaya	RMC1/16-00JTP

### Package Dimensions

Package dimensions for the 4-pin SOT-89 are shown in Figure 14, and tape and reel dimensions are provided in Figure 15.

### Package and Handling Information

Instructions on the shipping container label regarding exposure to moisture after the container seal is broken must be followed. Otherwise, problems related to moisture absorption may occur when the part is subjected to high temperature during solder assembly.

The SKY65080-70LF is rated to Moisture Sensitivity Level 1 (MSL1) at 260 °C. It can be used for lead or lead-free soldering.

Care must be taken when attaching this product, whether it is done manually or in a production solder reflow environment. Production quantities of this product are shipped in a standard tape and reel format. For packaging details, refer to the Skyworks Application Note *Tape and Reel*, document number 101568.

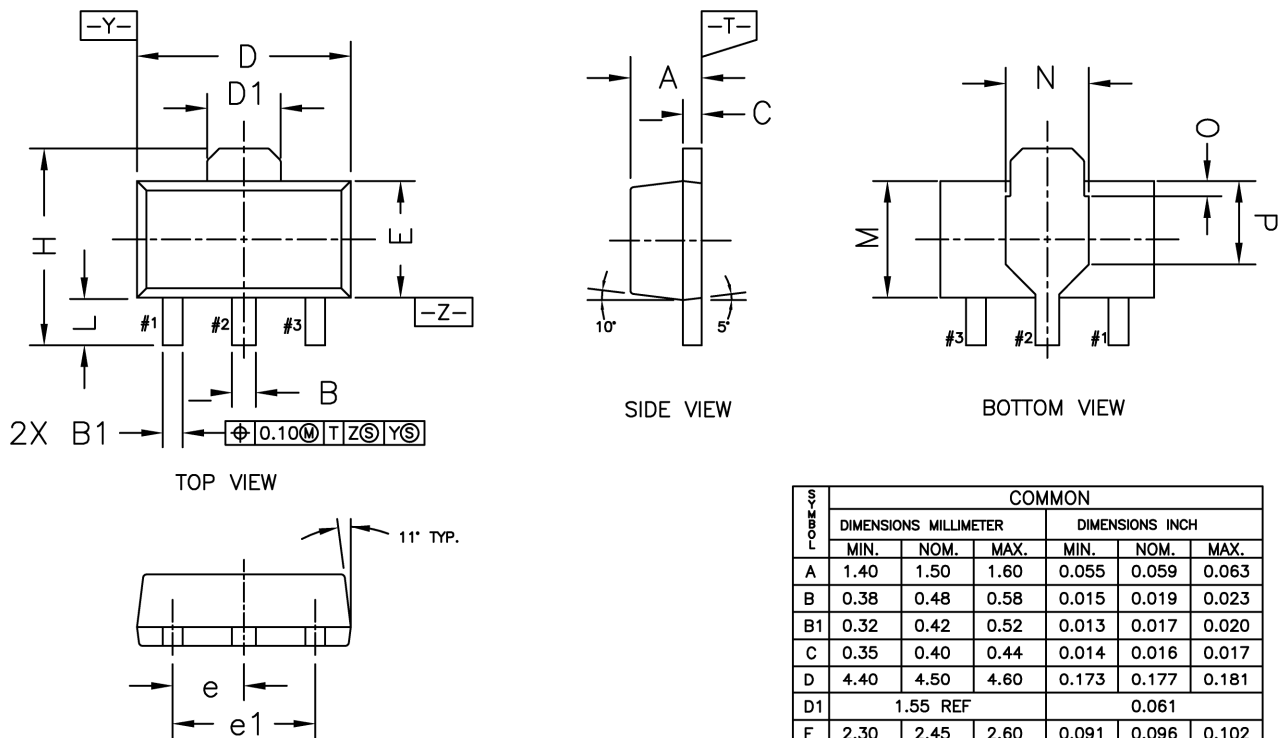

NOTES:

1. DIMENSIONING AND TOLERANCING CONFORM TO ANSI Y14.5M-1982.
2. PACKAGE DIMENSION DOES NOT INCLUDE MOLD PROTRUSIONS OR GATE BURRS. MOLD PROTRUSIONS AND GATE BURRS SHALL NOT EXCEED 0.005" PER END. BODY WIDTH DIMENSION DOES NOT INCLUDE INTERLEAD MOLD PROTRUSIONS. INTERLEAD PROTRUSIONS SHALL NOT EXCEED 0.005" PER SIDE.
3. LEADWIDTH DIMENSION DOES NOT INCLUDE DAMBAR PROTRUSIONS. ALLOWABLE PROTRUSION SHALL NOT EXCEED 0.002" TOTAL IN EXCESS OF LEAD WIDTH DIMENSION AT MAXIMUM MATERIAL CONDITION.
4. PLATING REQUIREMENT PER SOURCE CONTROL DRAWING (SCD) 2504.

SYMBOL	COMMON					
	DIMENSIONS MILLIMETER			DIMENSIONS INCH		
	MIN.	NOM.	MAX.	MIN.	NOM.	MAX.
A	1.40	1.50	1.60	0.055	0.059	0.063
B	0.38	0.48	0.58	0.015	0.019	0.023
B1	0.32	0.42	0.52	0.013	0.017	0.020
C	0.35	0.40	0.44	0.014	0.016	0.017
D	4.40	4.50	4.60	0.173	0.177	0.181
D1	1.55 REF			0.061		
E	2.30	2.45	2.60	0.091	0.096	0.102
e	1.50 BSC			0.059 BSC		
e1	3.00 BSC			0.118 BSC		
H	3.94	4.15	4.25	0.155	0.163	0.167
L	0.90	1.00	1.20	0.035	0.039	0.047
M	2.38 REF			0.094		
N	1.75 REF			0.069		
O	0.32 REF			0.013		
P	1.75 REF			0.069		

201042-014

Figure 14. SKY65080-70LF (4-Pin SOT-89) Package Dimensions



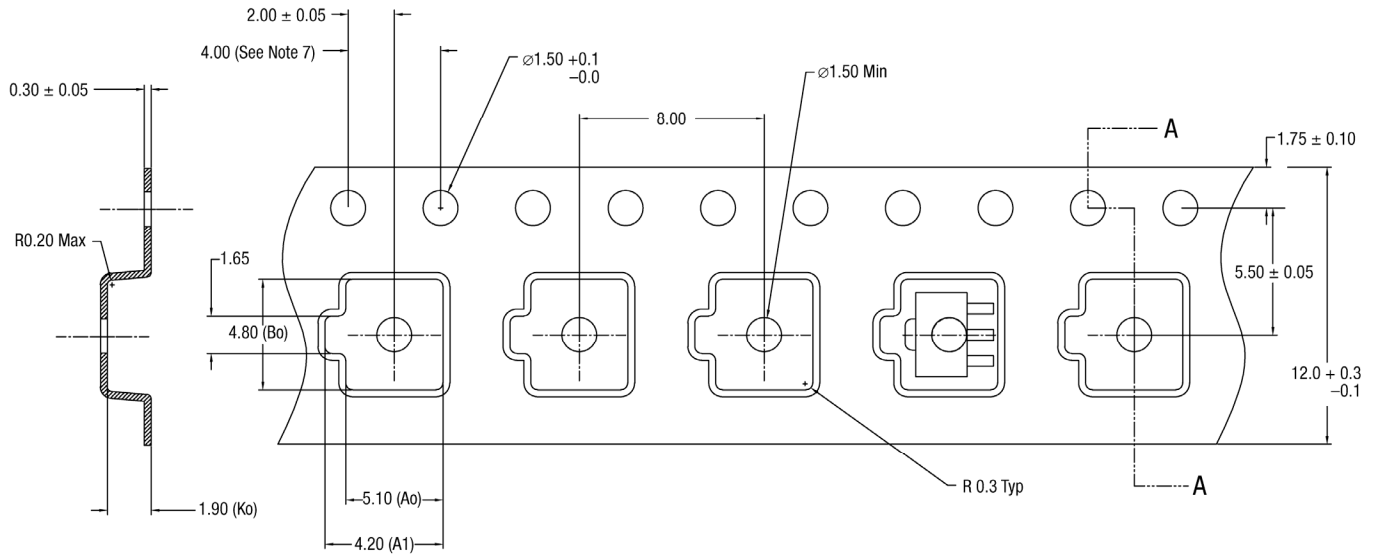

Notes:

1. Carrier tapes must meet all requirements of Skyworks GP01-D233 procurement spec for tape and reel shipping.
2. Carrier tape material: black conductive polycarbonate or polystyrene.
3. Cover tape material: transparent conductive PSA.  
Cover tape size: 9.2 mm width.
4. Typical ESD surface resistivity must meet all ESD requirements of Skyworks specified in GP01-D233.
5. Ao and Bo measurement point to be 0.30 mm from bottom pocket.
6. All measurements are in millimeters.
7. 10-sprocket hole pitch cumulative tolerance 0.2 mm.

201042-015

Figure 15. SKY65080-70LF Tape and Reel Dimensions

## Ordering Information

Part Number	Product Description	Evaluation Kit Part Number
SKY65080-70LF	1500 to 2500 MHz Low-Noise Power Amplifier Driver	SKY65080-70-EVB

Copyright © 2009, 2010, 2016-2018 Skyworks Solutions, Inc. All Rights Reserved.

Information in this document is provided in connection with Skyworks Solutions, Inc. (“Skyworks”) products or services. These materials, including the information contained herein, are provided by Skyworks as a service to its customers and may be used for informational purposes only by the customer. Skyworks assumes no responsibility for errors or omissions in these materials or the information contained herein. Skyworks may change its documentation, products, services, specifications or product descriptions at any time, without notice. Skyworks makes no commitment to update the materials or information and shall have no responsibility whatsoever for conflicts, incompatibilities, or other difficulties arising from any future changes.

No license, whether express, implied, by estoppel or otherwise, is granted to any intellectual property rights by this document. Skyworks assumes no liability for any materials, products or information provided hereunder, including the sale, distribution, reproduction or use of Skyworks products, information or materials, except as may be provided in Skyworks Terms and Conditions of Sale.

THE MATERIALS, PRODUCTS AND INFORMATION ARE PROVIDED “AS IS” WITHOUT WARRANTY OF ANY KIND, WHETHER EXPRESS, IMPLIED, STATUTORY, OR OTHERWISE, INCLUDING FITNESS FOR A PARTICULAR PURPOSE OR USE, MERCHANTABILITY, PERFORMANCE, QUALITY OR NON-INFRINGEMENT OF ANY INTELLECTUAL PROPERTY RIGHT; ALL SUCH WARRANTIES ARE HEREBY EXPRESSLY DISCLAIMED. SKYWORKS DOES NOT WARRANT THE ACCURACY OR COMPLETENESS OF THE INFORMATION, TEXT, GRAPHICS OR OTHER ITEMS CONTAINED WITHIN THESE MATERIALS. SKYWORKS SHALL NOT BE LIABLE FOR ANY DAMAGES, INCLUDING BUT NOT LIMITED TO ANY SPECIAL, INDIRECT, INCIDENTAL, STATUTORY, OR CONSEQUENTIAL DAMAGES, INCLUDING WITHOUT LIMITATION, LOST REVENUES OR LOST PROFITS THAT MAY RESULT FROM THE USE OF THE MATERIALS OR INFORMATION, WHETHER OR NOT THE RECIPIENT OF MATERIALS HAS BEEN ADVISED OF THE POSSIBILITY OF SUCH DAMAGE.

Skyworks products are not intended for use in medical, lifesaving or life-sustaining applications, or other equipment in which the failure of the Skyworks products could lead to personal injury, death, physical or environmental damage. Skyworks customers using or selling Skyworks products for use in such applications do so at their own risk and agree to fully indemnify Skyworks for any damages resulting from such improper use or sale.

Customers are responsible for their products and applications using Skyworks products, which may deviate from published specifications as a result of design defects, errors, or operation of products outside of published parameters or design specifications. Customers should include design and operating safeguards to minimize these and other risks. Skyworks assumes no liability for applications assistance, customer product design, or damage to any equipment resulting from the use of Skyworks products outside of stated published specifications or parameters.

Skyworks and the Skyworks symbol are trademarks or registered trademarks of Skyworks Solutions, Inc. or its subsidiaries in the United States and other countries. Third-party brands and names are for identification purposes only, and are the property of their respective owners. Additional information, including relevant terms and conditions, posted at [www.skyworksinc.com](http://www.skyworksinc.com), are incorporated by reference.